

PRINT TO ACTUAL SIZE US LETTER

BODY (A)

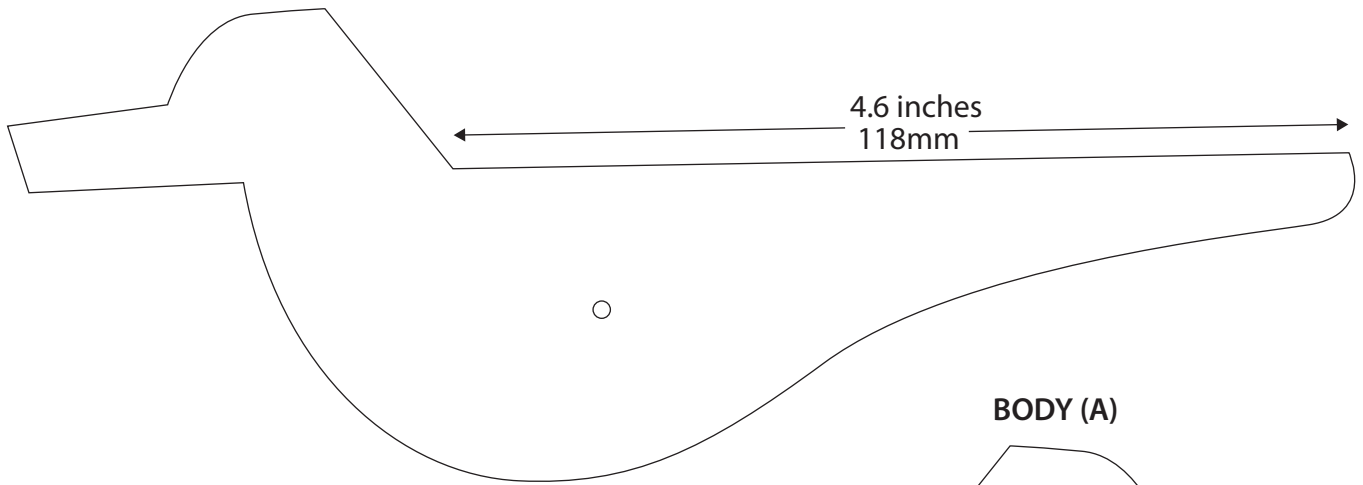

BODY (A)

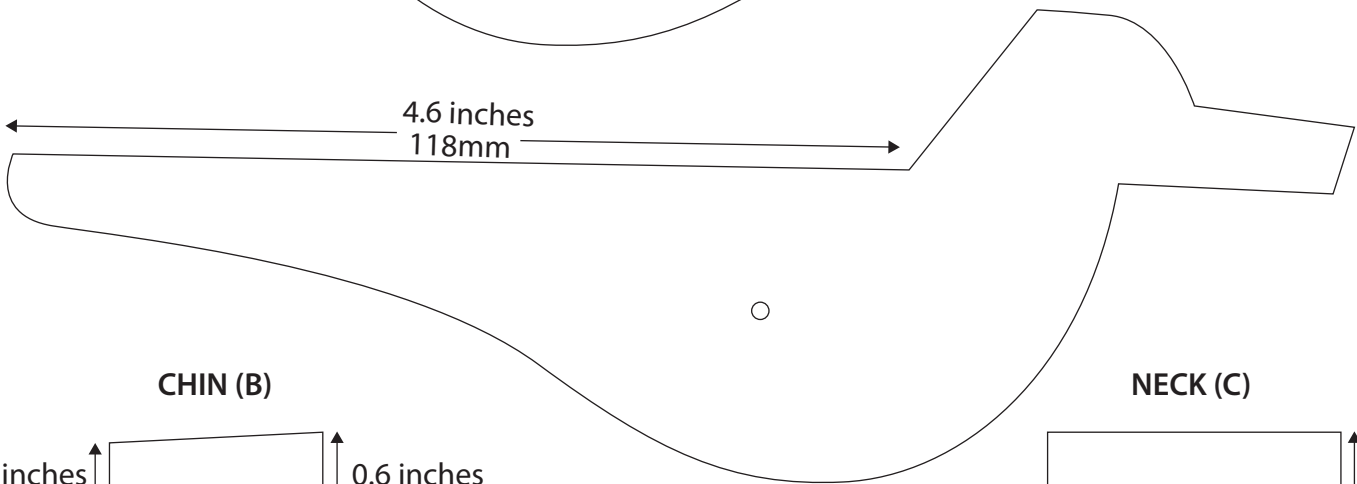

CHIN (B)

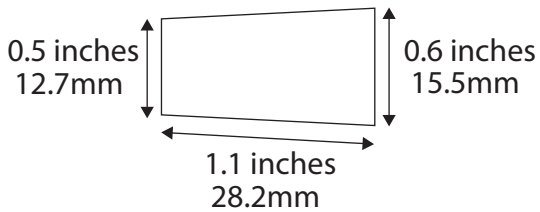

NECK (C)

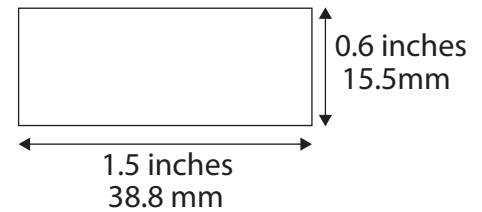

TOP BODY SECTIONS

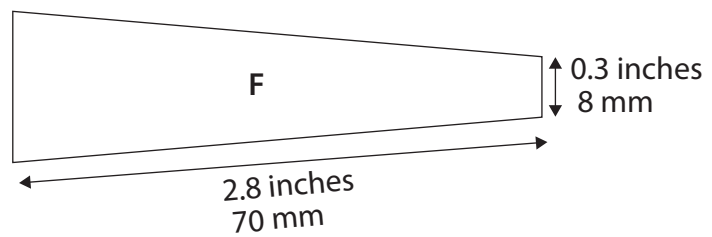
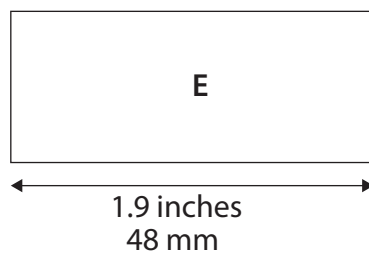
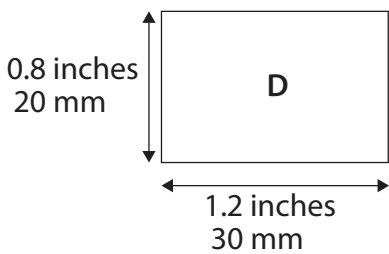

HEAD PARTS (G)

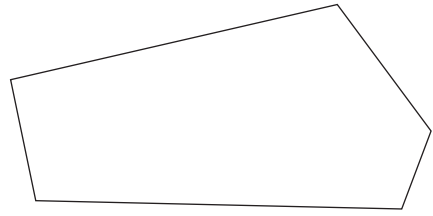
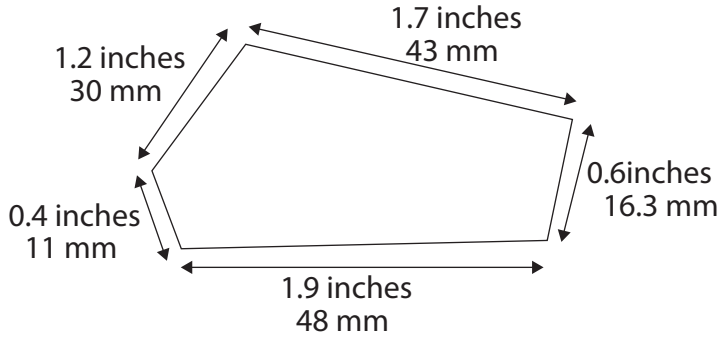

MIDDLE SUPPORT (H)

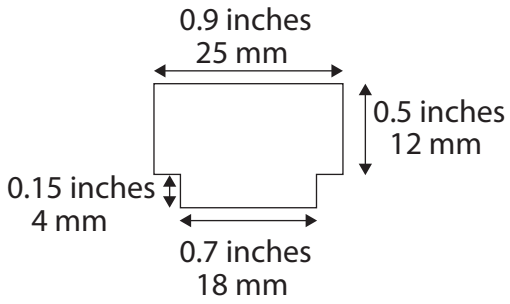

TOP HEAD SECTION (I)

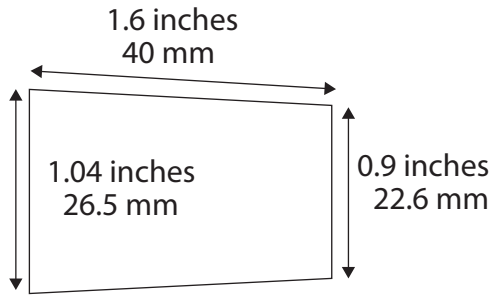

FRONT HEAD SECTION (J)

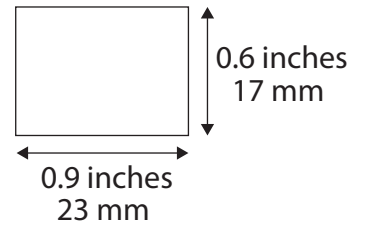

LEGS (K)

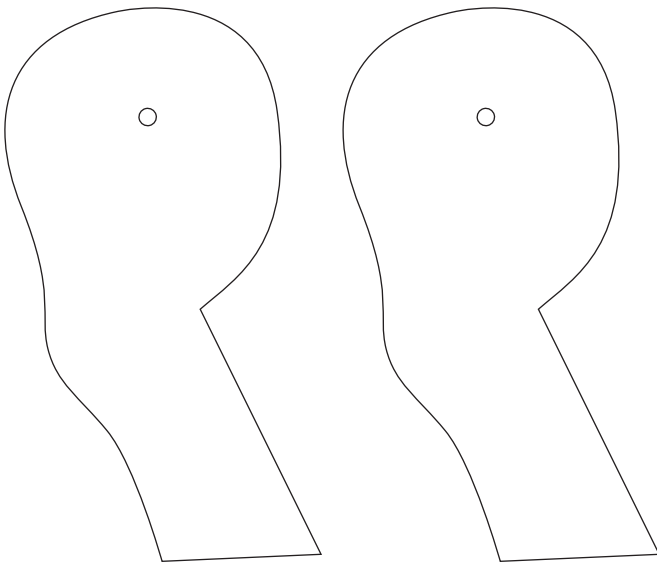

FEET (L)

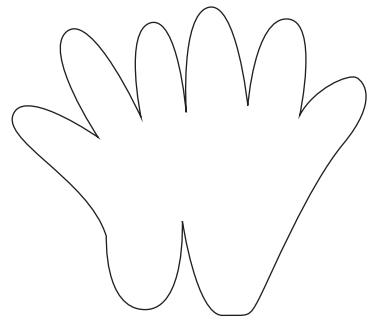

ARMS

